

Vented Disc with Parking Brake and Forged- Aluminum Four-Piston Calipers



12.19" Rotor
with Forged Dynalite Caliper



14" or 13" Rotor with
SL4R Radial-Mount Caliper

Billet Aluminum
Parking Brake and
Caliper Mounting
Bracket Assembly



Optional Red-Powder-
Coated Dynalite Caliper

Optional Red-
Powder-Coated SLR4 Caliper



SRP Series Rotors shown.

Available with smooth-surface, plain-finish HP
Series Rotors for extended high-temperature use

Rear Disc Brake Kit

Our rear disc brake kits feature rear-mounted, fixed, four-piston aluminum calipers and 12.19 or 13 x .81" or 14 x 1.10" vented rotors with an integrated parking brake mechanism. A combination disc/drum rotor assembly allows the parking brake components to be hidden neatly inside. Standard HP rotors are uncoated and feature a smooth abrasion surface, ideal for extended high-temperature operation. Kits can also be upgraded to slotted, cross-drilled and black E-coated SRP rotors for a high-quality modern appearance. Our enhanced-friction ceramic-formula brake pads provide smooth engagement and long service life with low noise and brake-dust levels for performance driving applications. Kits are available for most standard housing ends and require 15" (12.19" rotor), 17" (13" rotor), 18" (14" rotor), or larger wheels for proper caliper clearance.

Street 12.19" Rear Discs

Forged Dynalite Caliper

The Wilwood 12.19" rear disc brake kit uses Forged Dynalite (FDL) four-piston, aluminum, lug-mount calipers for their superior rigidity and enhanced braking performance and pedal feel. The calipers use a closed-end, internal fluid passage design that is further strengthened by four steel bridge bolts extending through the caliper body. Stress-flow forging and smooth surface transitions help eliminate stress points and reduce overall caliper deflection.



Optional red powder-coated caliper

FDL calipers use one-piece, 1.38"-bore, stainless-steel pistons and high-temperature, square-faced bore seals. Stainless steel slows heat transfer to the brake fluid and improves the system's resistance to heat-induced pedal fade. This reduction in heat also increases the service life of the fluid and seals. The four individual pistons apply pressure against both sides of the rotor. Caliper fluid requirements are matched to the output capabilities of commonly used factory master cylinders ensuring comfortable performance in a wide range of applications.

The Dynalite calipers are trouble-free and service-friendly. Vibration-dampening, stainless-steel bridge-plate inserts protect the caliper body from wear caused by pad movement, greatly extending service life. Two-piece bleed screws are easily accessed at each corner of the caliper and eliminate direct wear to the aluminum body. Brake pads are also easily changed by simply removing the retaining pin and sliding the pads out.

High-Performance Disc/Drum Rotors

The kit comes standard with HP series 12.19 x .81" vented, smooth-surface rotors with an integrated drum. The HP rotors come uncoated and can withstand extreme operating temperatures for extended periods of time; ideal for high-performance applications. For more eye-catching high-end street performance, SRP series vented, cross-drilled, slotted, and black E-coated rotors are available. To maximize cooling surface area, 32 individual air passages are cast internally into each rotor. Air passages or vents offer increased airflow and cooling capability over standard solid-rotor designs. The optional SRP rotor with slotted surface and cross-drilled holes improves pad-to-rotor contact by wiping the pads clean and allowing brake dust and gases to be easily exhausted.



HP Rotor

SRP Rotor



Billet Aluminum Bracket Assembly

The parking brake and caliper mounting bracket assembly is machined from lightweight, high-strength billet aluminum. Structural mounting points on each bracket receive spline-threaded steel inserts, reducing the mounting hardware and simplifying installation. All components are anodized, painted, or plated for corrosion resistance and extended service life. Brackets are available for all standard housing ends.

Performance 14" and 13" Rear Discs

Billet SL4R Radial-Mount Caliper

The Performance 14" and 13" kits use Wilwood's SL4R four-piston, billet aluminum, radial-mount calipers for their superior rigidity and enhanced braking performance and pedal feel. These calipers use a closed-end design that is further strengthened by five steel bridge bolts extending through the caliper body and directly across the brake pads. Smooth surface transitions help eliminate stress points and reduce overall caliper deflection.

The SL4R caliper uses lightweight, coated aluminum pistons and high-temperature rubber boots to seal out debris from the piston bores. The total seal design reduces unnecessary wear, increasing the service life of the pistons. The four individual pistons apply pressure against both sides of the rotor. Caliper fluid requirements are matched to the output capabilities of commonly used factory master cylinders ensuring comfortable performance in a wide range of applications.



Optional red powder-coated caliper

SL4R calipers are trouble-free and service-friendly. Vibration-dampening, stainless-steel bridge-plate inserts protect the caliper body from wear caused by pad movement, greatly extending service life. Dampened external fluid tubes are routed through recessed pockets to keep clear of debris and reduce the potential of vibration-induced wear at the fittings. Two-piece bleed screws are easily accessed at the top of each side of the caliper and eliminate direct wear to the aluminum body. Brake pads are also easily changed by simply removing the center bridge bolt and sliding the pads out.

High-Performance Vented Disc Rotors

The kit comes standard with HP series 14 x 1.10" or 13 x .81", vented, smooth-surface rotors with an integrated drum. The HP rotors come uncoated and can withstand extreme operating temperatures for extended periods of time; ideal for high-performance applications. For more eye-catching high-end street performance, SRP series vented, cross-drilled, slotted, and zinc-washed rotors are available. To maximize cooling surface area, individual air passages are cast internally into each rotor. Air passages or vents offer increased airflow and cooling capability over standard solid-rotor designs. The optional SRP rotor with slotted surface and cross-drilled holes improves pad-to-rotor contact by wiping the pads clean and allowing brake dust and gases to be easily exhausted.

Two-Piece Steel-Hat Drum

Separate machine-finished, steel hats provide the holding drum for the parking brake shoes and allow components to be easily replaced if damaged or worn. Hats use a solid-wall, cylindrical design to improve rotor stability. Rotors and hats are secured in a 12-bolt configuration to provide additional stability to the rotor. Hats are drilled for multiple five-lug bolt patterns and accept 1/2" wheel studs.

Billet Aluminum Bracket Assembly

The parking brake and caliper mounting bracket assembly is machined from lightweight, high-strength billet aluminum. Structural mounting points on each bracket receive spline-threaded steel inserts, reducing the mounting hardware and simplifying installation. All components are anodized, painted, or plated for corrosion resistance and extended service life. Brackets are available for all standard housing ends.

Exploded Diagrams

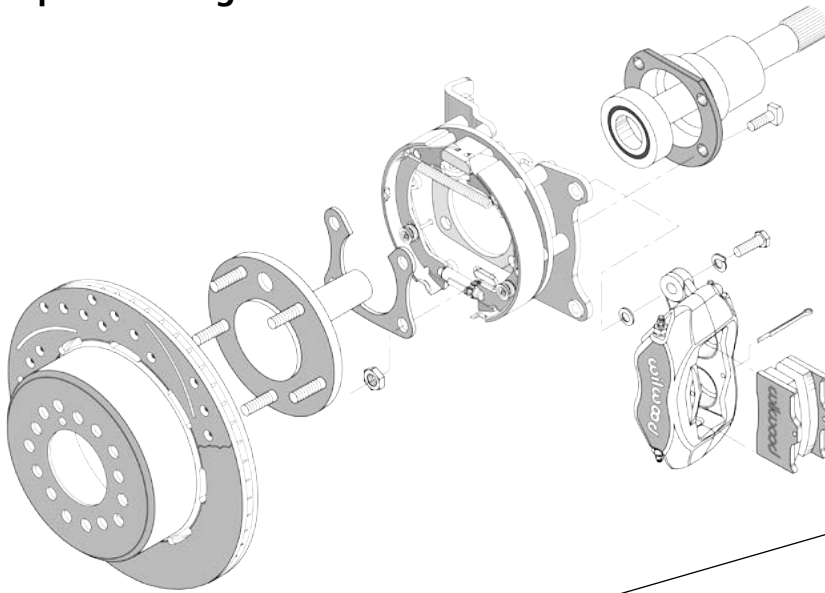

Street 12.19" Kit
One-Piece Disc/Drum
Forged Dynalite Caliper

Performance 13" Kit
Two-Piece Disc/Drum Assembly
SL4R Radial-Mount Caliper

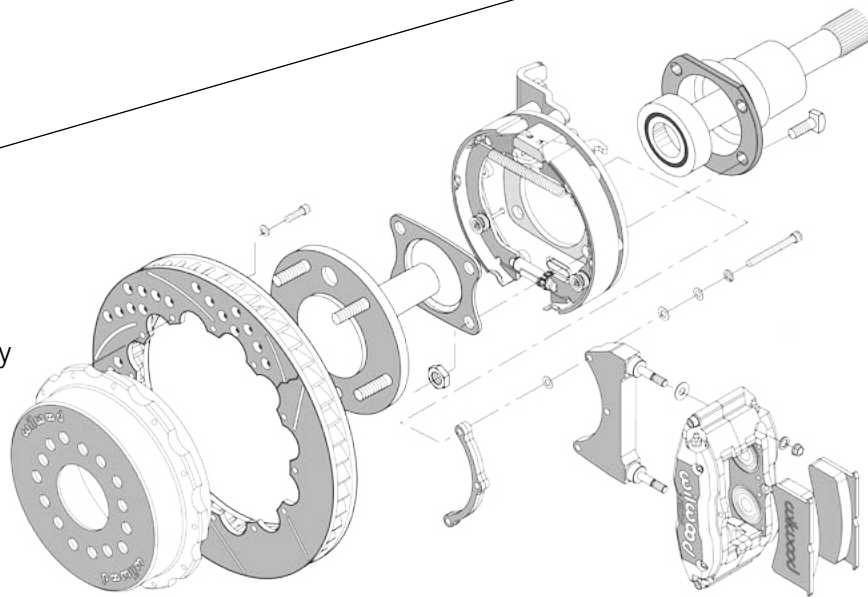

Housing-End Diagrams

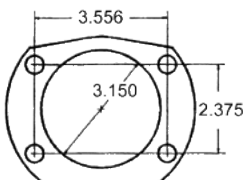

BIG FORD (EARLY)

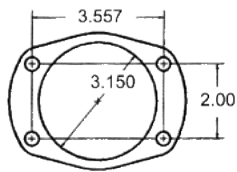

BIG FORD (LATE/TORINO)

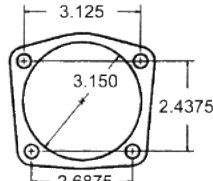

SMALL GM (SPECIAL)

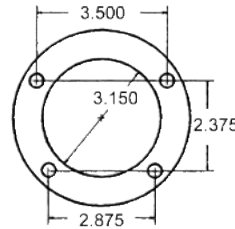

OLDS/PONTIAC

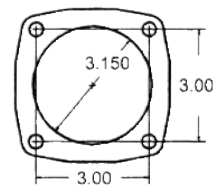

SYMMETRICAL

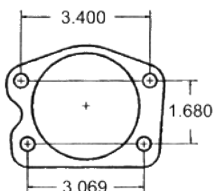

FORD 8.8" (OEM) C-CLIP ELIM. KITS

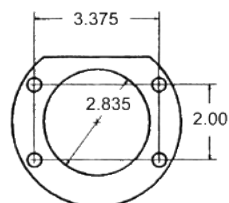

SMALL FORD (EARLY MUSTANG)

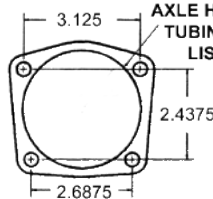

SMALL GM (OEM) C-CLIP ELIM. KITS (64-72 2.725 OD) (93-02 2.840 OD)

AXLE HOUSING TUBING O.D. LISTED

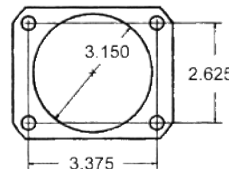

LARGE GM (BLAZER/IMPALA)

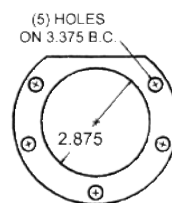

MOPAR/DANA 8-3/4 - 9-3/4

Applications

Housing Style	Axle Offset	Performance 14" ¹	
		HP Rotor	SRP Rotor
Big Ford (Late/Torino)	2.50"	WW 140-10012	WW 140-10012-D

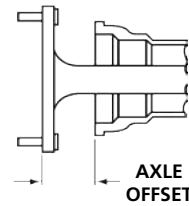

Axle offset is measured from face of housing end to outside face of axle flange.

Note: Optional red caliper

Housing Style	Axle Offset	Performance 13" ¹		Street 12.19" ²	
		HP Rotor	SRP Rotor	HP Rotor	SRP Rotor
Small Ford (Early Mustang)	2.66"	WW 140-9216	WW 140-9216-D	WW 140-7143	WW 140-7143-D
Big Ford (Early)	2.36"	WW 140-9217	WW 140-9217-D	WW 140-7139	WW 140-7139-D
Big Ford (Late)	2.36"	WW 140-9218	WW 140-9218-D	WW 140-7582	WW 140-7582-D
Big Ford (Late/Torino)	2.50"	WW 140-9219	WW 140-9219-D	WW 140-7140	WW 140-7140-D
8.8" Ford (5-lug no ABS/Traction Control)	2.50"	WW 140-9223	WW 140-9223-D	WW 140-7146	WW 140-7146-D
8.8" Ford (5-lug 2005-Present)	2.66"	WW 140-9221	WW 140-9221-D	WW 140-9228	WW 140-9228-D
Camaro/Firebird '93-02	2.75"	-	-	WW 140-7148	WW 140-7148-D
Small GM w/ C-Clips	2.81"	WW 140-9213	WW 140-9213-D	WW 140-7141	WW 140-7141-D
Small GM w/ C-Clips	2.75"	-	-	WW 140-7149	WW 140-7149-D
Small GM Special	2.81"	WW 140-9215	WW 140-9215-D	WW 140-7578	WW 140-7578-D
Small GM (Staggered Shock Mount)	2.75"	-	-	WW 140-9315	WW 140-9315
Mopar/Dana (Green Bearing w/ Span Ring)	2.36"	WW 140-9222	WW 140-9222-D	WW 140-7144	WW 140-7144-D
Olds/Pontiac	2.81"	WW 140-9224	WW 140-9224-D	WW 140-7147	WW 140-7147-D

Note: Optional red caliper

Wheel-Clearance Diagram

Street 12.19"

Housing End	Part Number	Dimension "A"
Small Ford (Early Mustang)	WW 140-7143	0.67"
Big Ford (Early)	WW 140-7139	0.24"
Big Ford (Late)	WW 140-7582	0.24"
Big Ford (Late/Torino)	WW 140-7140	0.24"
8.8" Ford (5-lug no ABS/Traction Control)	WW 140-7146	0.24"
8.8" Ford (5-lug 2005-Present)	WW 140-9228	0.61"
Camaro/Firebird '93-02	WW 140-7148	0.67"
Small GM w/ C-Clips	WW 140-7141	0.67"
Small GM w/ C-Clips	WW 140-7149	0.67"
Small GM Special	WW 140-7578	0.67"
Small GM (Staggered Shock Mount)	WW 140-9315	0.67"
Mopar/Dana (Green Bearing w/ Span Ring)	WW 140-7144	0.24"

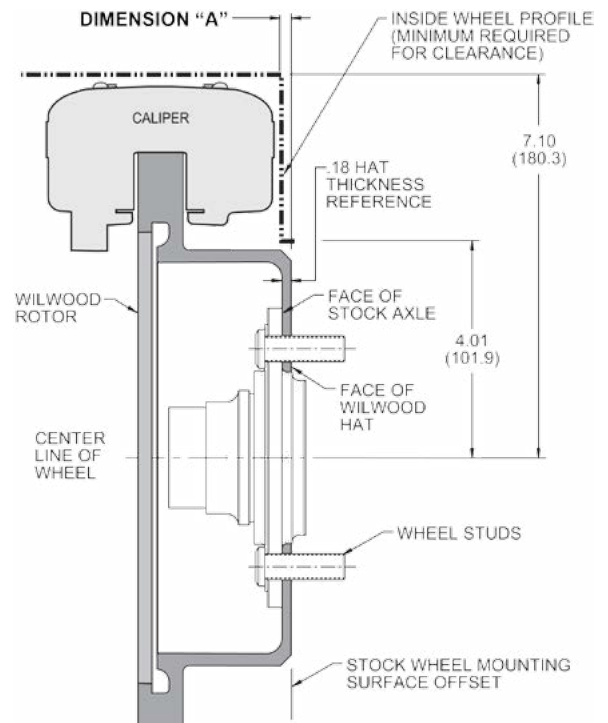

Wheel-Clearance Diagrams

Performance 13"

Housing End	Performance 13"	Caliper Position	Dimension "A"	Dimension "B"
Small Ford (Early Mustang)	WW 140-9216	Recessed	0.07"	0.57"
Big Ford (Early)	-	-	-	-
Big Ford (Late)	WW 140-9218	Protruding	0.34"	0.14"
Big Ford (Late/Torino)	WW 140-9219	Protruding	0.34"	0.14"
8.8" Ford (5-lug no ABS/Traction Control)	WW 140-9223	Protruding	0.34"	0.14"
8.8" Ford (5-lug 2005-Present)	WW 140-9221	Recessed	0.07"	0.57"
Camaro/Firebird '93-02	-	-	-	-
Small GM w/ C-Clips	WW 140-9213	Recessed	0.07"	0.57"
Small GM w/ C-Clips	-	-	-	-
Small GM Special	WW 140-9215	Recessed	0.07"	0.57"
Small GM (Staggered Shock Mount)	-	-	-	-
Mopar/Dana (Green Bearing w/ Span Ring)	WW 140-9222	Protruding	0.34"	0.14"

Protruding Caliper

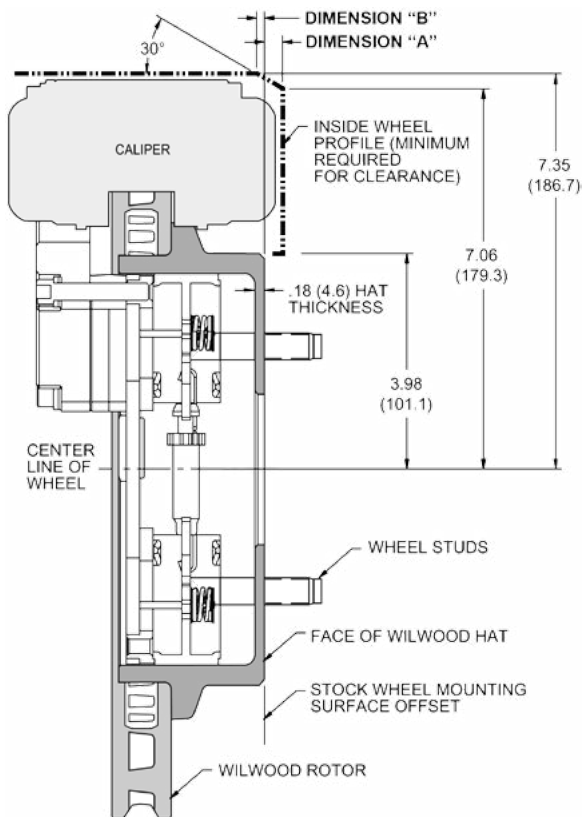

Recessed Caliper

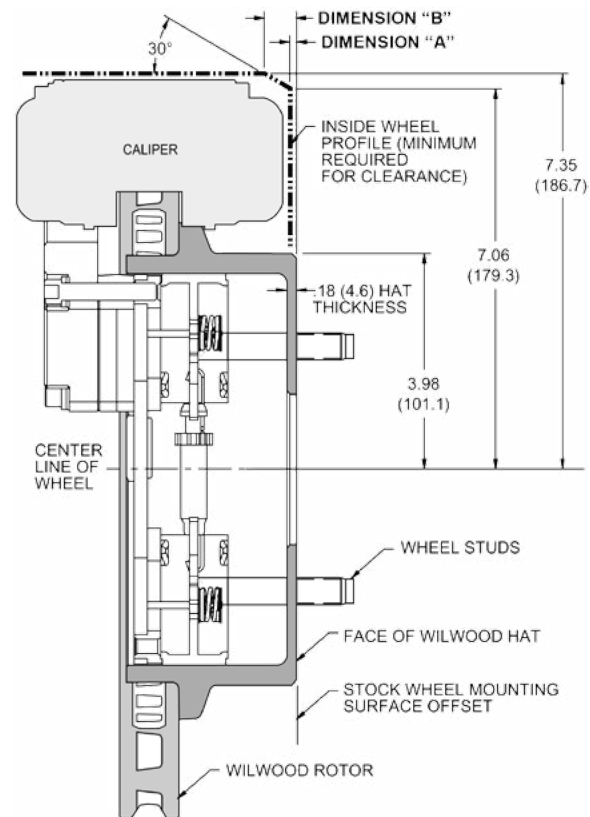

All prices subject to change. Current pricing available at www.cachassisworks.com.



Chris Alston's Chassisworks, Inc.
8661 Younger Creek Drive
Sacramento, CA 95828

Order: 800-722-2269
Tech: 916-388-0288
Fax: 916-388-0295

sales@cachassisworks.com
www.cachassisworks.com